

Time-Pressure Controller User Guide

Version 1.1
February 12, 2018
Part No. 22391038M

for use with Time-Pressure Controller - PN 22391062



prepared by GPD Global® Documentation Dept.



611 Hollingsworth Street
Grand Junction, CO, USA 81505
tel: +1.970.245-0408 • fax +1.970.245-9674
request@gpd-global.com • www.gpd-global.com

Copyright © 2018 GPD Global® • All Rights Reserved

Contents

- Warranty iii
- Overview 1
 - Features 1
 - Applications 1
 - Standard Accessories 1
 - Precautions 1
 - Dimensions 2
 - Specifications 2
 - Description 3
- Setup 4
- Settings 5
 - Units 5
 - Dispense Time 6
 - Dispense Mode 7
- How to Use Controller 8
 - Needle / Syringe Air Exhaust 8
 - Pressure Control 8
- Input / Output Signals 8
 - Time (Auto) Mode 8
 - Manual Mode 9
 - Interval Mode 9
- Troubleshooting 10
- Maintenance, Supplies 10
- Spare Part 10

Warranty

General Warranty. Subject to the remedy limitation and procedures set forth in the Section “Warranty Procedures and Remedy Limitations,” GPD Global warrants that the system will conform to the written description and specifications furnished to Buyer in GPD Global’s proposal and specified in the Buyer’s purchase order, and that it will be free from defects in materials and workmanship for a period of one (1) year. GPD Global will repair, or, at its option, replace any part which proves defective in the sole judgment of GPD Global within one (1) year of date of shipment/invoice. Separate manufacturers’ warranties may apply to components or subassemblies purchased from others and incorporated into the system. THIS WARRANTY IS EXPRESSLY IN LIEU OF ANY AND ALL OTHER WARRANTIES, EXPRESS OR IMPLIED, INCLUDING WARRANTIES OF MERCHANTABILITY OR FITNESS FOR A PARTICULAR PURPOSE.

Limitations. GPD Global reserves the right to refuse warranty replacement, where, in the sole opinion of GPD Global the defect is due to the use of incompatible materials or other damages from the result of improper use or neglect.

This warranty does not apply if the GPD Global product has been damaged by accident, abuse, or has been modified without the written permission of GPD Global.

Items considered replaceable or rendered unusable under normal wear and tear are not covered under the terms of this warranty. Such items include fuses, lights, filters, belts, etc.

Warranty Procedures and Remedy Limitations. The sole and exclusive remedy of the buyer in the event that the system or any components of the system do not conform to the express warranties stated in the Section “Warranties” shall be the replacement of the component or part. If on-site labor of GPD Global personnel is required to replace the non-warranted defective component, GPD Global reserves the right to invoice the Buyer for component cost, personnel compensation, travel expenses and all subsistence costs. GPD Global’s liability for a software error will be limited to the cost of correcting the software error and the replacement of any system components damaged as a result of the software error. In no event and under no circumstances shall GPD Global be liable for any incidental or consequential damages; its liability is limited to the cost of the defective part or parts, regardless of the legal theory of any such claim. As to any part claimed to be defective within one (1) year of date of shipment/invoice, Buyer will order a replacement part which will be invoiced in ordinary fashion. If the replaced part is returned to GPD Global by Buyer and found by GPD Global in its sole judgment to be defective, GPD Global will issue to Buyer a credit in the amount of the price of the replacement part. GPD Global’s acceptance of any parts so shipped to it shall not be deemed an admission that such parts are defective.

Specifications, descriptions, and all information contained in this manual are subject to change and/or correction without notice.

Although reasonable care has been exercised in the preparation of this manual to make it complete and accurate, this manual does not purport to cover all conceivable problems or applications pertaining to this machine.

Overview

The Time-Pressure Controller digitally controls dispensing across a wide range of material viscosities. The controller is compact and light weight.



Features

- Easy to use and maintain
- Wide variety of dispensing applications
- Digital display
- Suitable for all types of fluids, including paste
- Light weight and compact size

Applications

Materials: Cream solder, Silver paste, Epoxies, Bond, Oil, etc.

Patterns: Dots, Lines

Standard Accessories

- Foot switch
- Power cords

Precautions

Before connecting air to the AIR IN port, turn the REGULATOR knob all the way to the left. After air pressure is available to the controller, you may increase/adjust air pressure with the REGULATOR knob.

DO NOT connect AC 110V power source to Signal Port or internal circuit damage will occur. This port is intended for use with a foot switch or other approved device.

To prevent malfunctions, maintain the air cap/syringe/needle assembly in a vertical orientation.

Keep controller and all items connected to it clean and free of contamination (dust, oil, etc.).

Use only clean dry air filtered with a 5 micron filter.

Maintain a separate power source for the controller if it is to be used with devices that generate noise (for example: motor, part feeder, etc.).

Dimensions

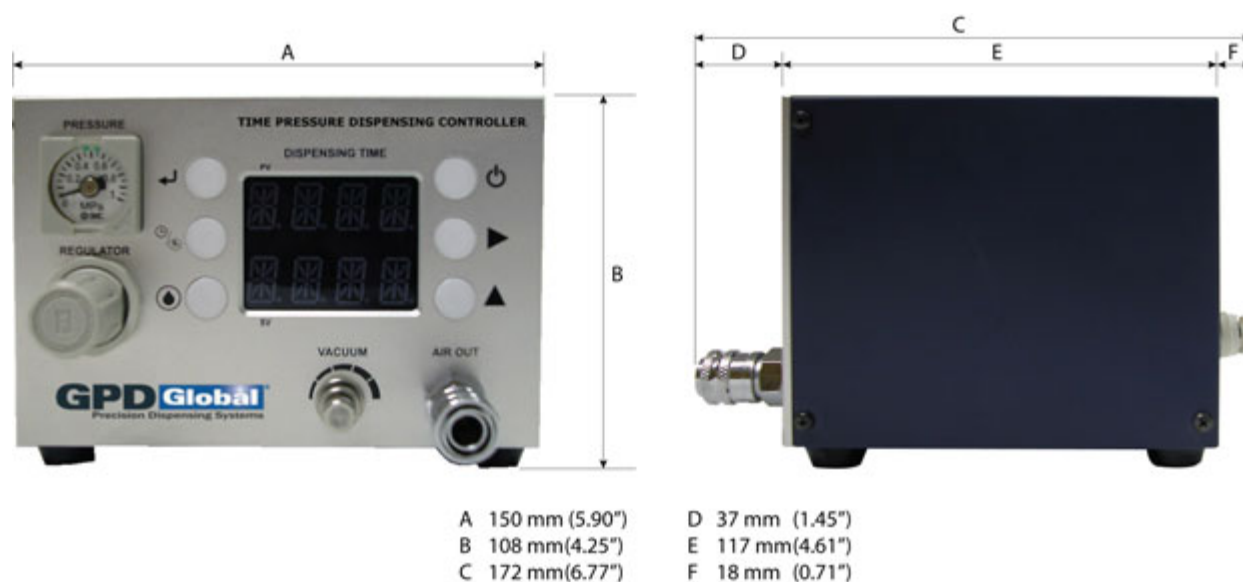







Specifications

Specification	Value
Power	110-220V AC $\pm 10\%$, 50-60 Hz
Power Consumption	5 W
Air	Up to 140 psi (Up to 9.9 Kg/cm ²)
Air Pressure - Input (max)	100 psi (7 Kg/cm ²)
Dispense Time Range	0.005-99.99 sec
User Interface	Push Button
Operation Modes	<ul style="list-style-type: none"> • Manual Mode: continuous dispense • Timed Mode: time setting Manual Mode • Interval Mode: continuous repetition
Temperature Range	-5° C - 40° C (-23° F to 104° F)
Dispense Trigger Signal	Foot Switch / Dry Contact Potential-free NO
Signal Output	Non-contact N.O.contact output
Dimensions (W x D x H)	150 x 172 x 108 mm (5.9" x 6.8" x 4.25")
Weight	1.5 kg (3.31 lbs.)
Cable Length (foot switch)	173 cm (68")

Description



Item	Label	Icon	Operation & Function
1	PRESSURE, REGULATOR		<ul style="list-style-type: none"> Knob adjusts dispense pressure. Increase pressure with clockwise rotation. Decrease pressure with counterclockwise rotation.
2	SHOT		<p>Press briefly to dispense a shot per Settings (pg 5).</p> <p>When in MANUAL mode, air pressure activates for as long as you depress and hold this button.</p>
3	Auto / Manual Interval		<ul style="list-style-type: none"> To change between AUTO and MANUAL modes, press briefly (less than 3 seconds). To change to INTERVAL mode, press longer than 3 seconds.
4	MODE (RESET)		<ul style="list-style-type: none"> Functions as RESET (ENTER) button when pressed briefly (less than 3 seconds). Functions as mode selector switch when depressed and held for longer than 3 seconds. Selects between UNIT mode (decimal places) and TEST mode (button inspection).
5	DISPENSING TIME PV SV		<p>Dispense time values are displayed here:</p> <ul style="list-style-type: none"> PV is the current time value. SV is the set time value. Set time value is also set here.
6	MODE display		<ul style="list-style-type: none"> Displays currently selected mode: AUTO, MANUAL, or INTERVAL. Interval number is displayed in INTERVAL mode.
7	Power S/W		Turns controller power ON / OFF.
8	Cursor		<p>Press briefly during the time setting process to move the cursor to the next digit in the displayed value.</p> <p>Can also be used for interval mode.</p>
9	Up		Increases the value of the displayed digit by “1” when pressed briefly.
10	VACUUM		<p>Used to regulate drooling and suckback for low viscosity materials.</p> <ul style="list-style-type: none"> To increase vacuum, turn clockwise. To decrease vacuum, turn counterclockwise.
11	AIR OUT		Port provides air pressure for dispense pump.



Item	Label	Operation & Function
12	Exhaust Port	Exhausts and muffles generated vacuum.
13	Signal Port	Input/Output port to foot switch or other external device for dispense Start/Stop signal.
14	Air In	Pneumatic hose (6 mm) connection port.
15	Fuse Holder	Circuit protective fuse.
16	Power Supply	Connection port for the supplied power cord.

Setup



1. Verify the POWER S/W button on the front panel is turned OFF.
2. Connect air hose to AIR IN port (Item A).
3. Connect power cord into Power Supply (Item C) and wall outlet.

NOTE: Connect ground.

4. Connect foot switch to Signal Port (Item B).
5. Connect syringe air cap hose to AIR OUT on the front panel.
6. Verify syringe is clean and dry.
7. Fill syringe 70-80% full.
8. Attach the syringe air cap to the filled syringe.

Settings

Units

Unit settings are used to set up and test dispense time.

- Dispense time can be set at 0.001 to 99.99 seconds.
- INTERFACE mode can be set to an interval between 0.001 and 9.999 seconds.

Press the RESET button until the display changes.



To go to TEST mode (button inspection), briefly press the CURSOR button to return to UNIT. Then press the CURSOR button again.



Briefly press the UP button to change the location of the decimal point.



Press the RESET button again to save settings and exit from UNIT / TEST modes.



Dispense Time

Dispense time is used for both the TIME mode and INTERVAL mode.

- Present value (PV) displays in the upper portion of DISPENSING TIME. Set value (SV) displays in the lower portion.
- The UP button increments digit value.

1. To edit dispense time, press the CURSOR button. The top left digit will flash.

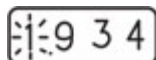

2. Use the CURSOR button to select the digit you want to change. Then briefly press the UP button to increment the selected digit to desired value.

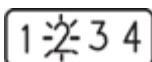
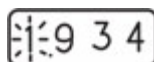

3. When done, press the RESET button to save the set value.

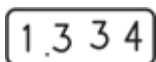

Dispense Mode

There are three dispense modes: MANUAL, TIME, and INTERVAL.

- Dispense time can be set at 0.001 to 99.99 seconds.
 - INTERFACE mode can be set to an interval between 0.001 and 9.999 seconds.
1. Briefly press the Auto/Manual Interval button to switch between TIME (Auto) and MANU (Manual) modes.

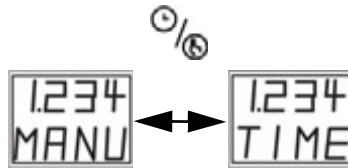

2. Press the Auto/Manual Interval button for 3 or more seconds to switch to INT (Interval) mode.

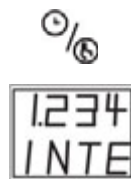

3. After selecting the time value, press the RESET button to save the set value.



How to Use Controller

Needle / Syringe Air Exhaust

- Needle syringe air exhaust - Vacuum.
- Make adjustments if material drools through the needle.
- Increase air pressure by turning the REGULATOR knob clockwise.
- Do not use an excessive amount of vacuum or stopper may pull away from the syringe.

Pressure Control

1. With zero pressure (PRESSURE gauge should read 0 kgf/cm²), verify the controller is in Manual mode.
2. Press and hold down the foot switch while slowly turning the REGULATOR knob clockwise to increase pressure until desired dispense results are achieved.
3. Continue dispense until material is purged from system.

NOTE: Control dispense with foot switch.

NOTE: Before removing or replacing the syringe needle, remove air pressure by turning the REGULATOR knob counterclockwise.

Input / Output Signals

Time (Auto) Mode

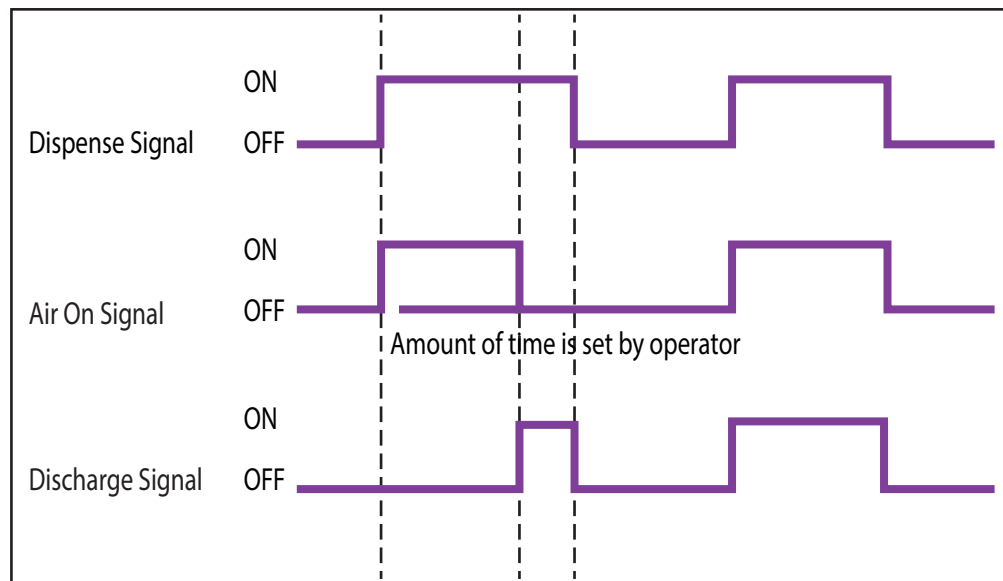

If the Dispense signal is greater than the Air On signal, the Discharge signal turns on.

Manual Mode

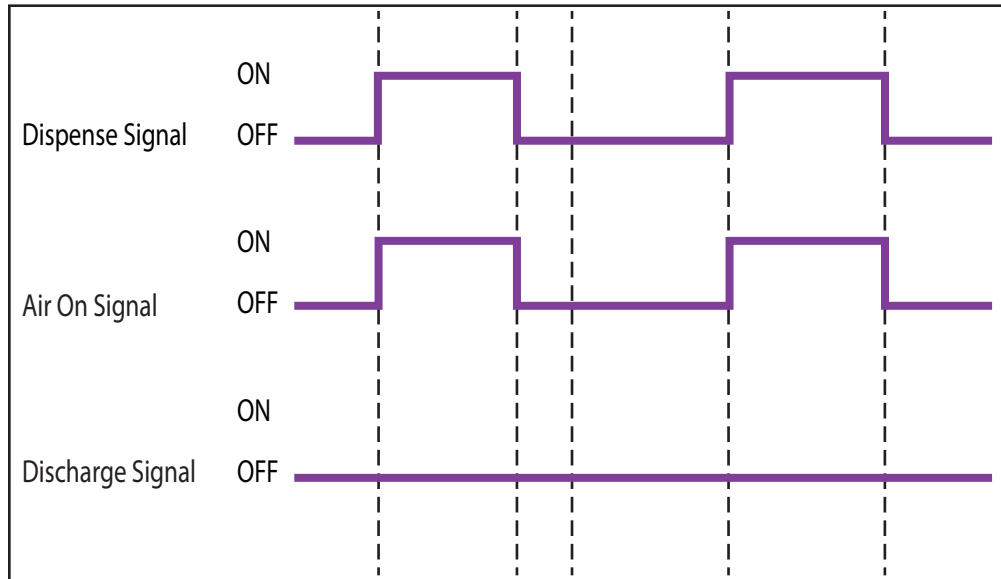

The Dispense signal and Air On signal are always the same during MANUAL mode.

Interval Mode

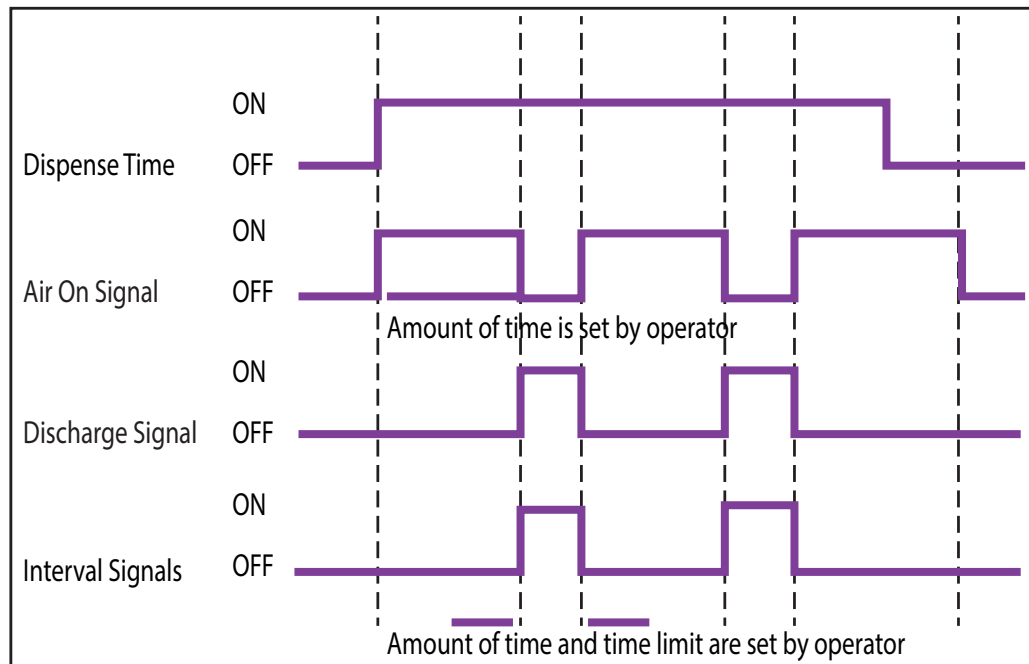

Set the Dispense Time and Delay time within a 0.01-9.99s range.

Input / Output Signal Connection

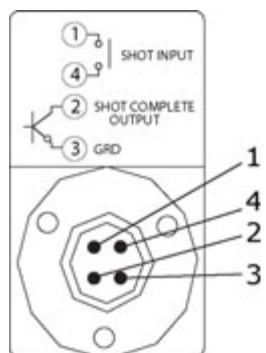

Troubleshooting

Pressure is slow

Using the REGULATOR knob, reduce PRESSURE so it is lower than the set pressure shown in the SV portion of the DISPENSING TIME display.

Maintenance, Supplies

The controller typically requires little to no maintenance as long as the following precautions are observed and practiced:

- Do not stress the hose at the AIR OUT connection.
- Contact GPD Global if controller requires repairs.
- Do not exceed pressure stated in [Specifications](#) (pg 2).

Spare Part

Description	Part No.	Qty
Air Connector 	2675-0135	1